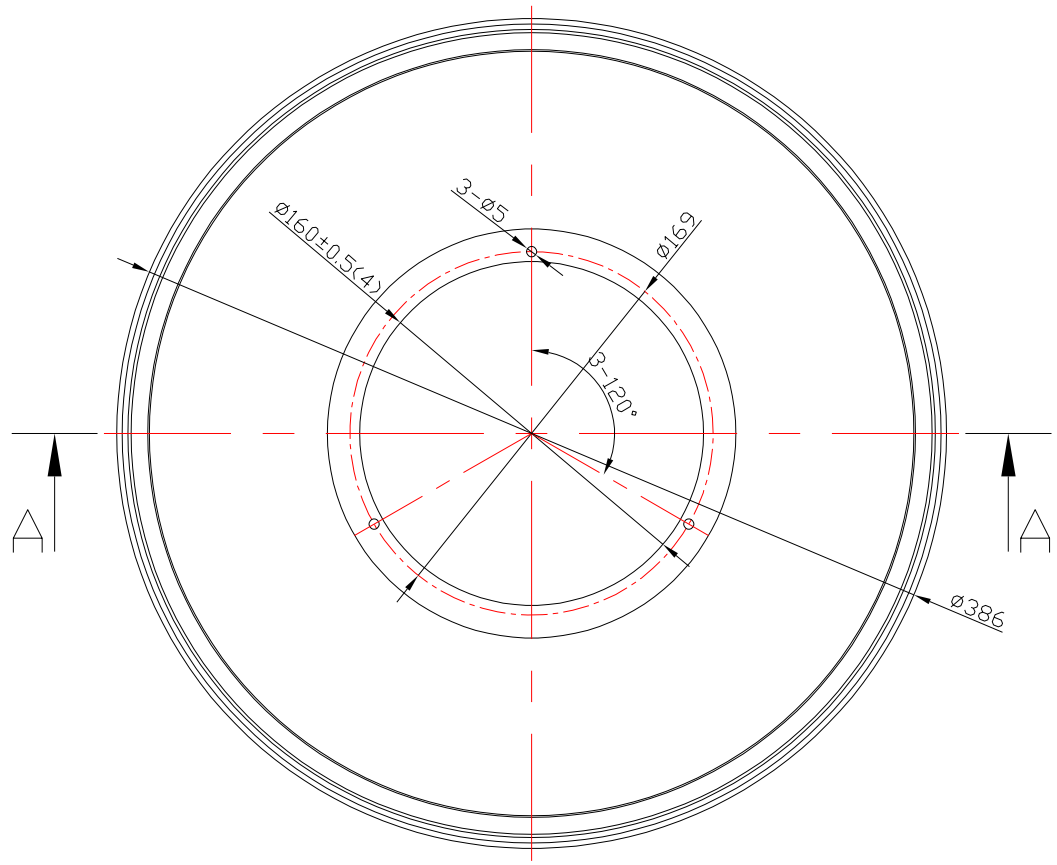
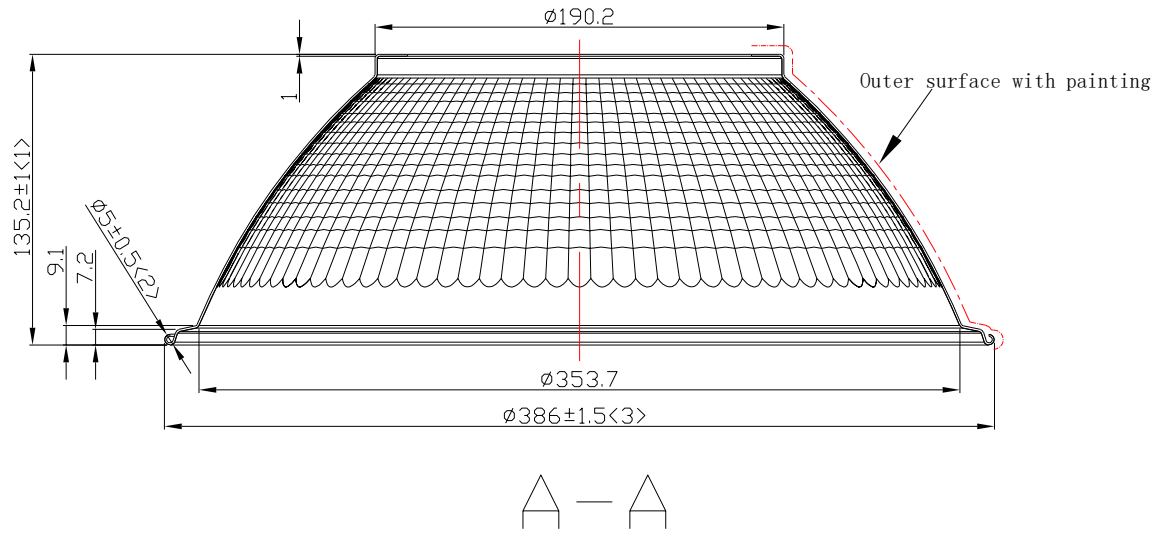

table for unmentioned tolerance in the drawing (unit: mm)			punch angle tolerance in the drawing (unit:degree)		
0-5	5-30	30-120	0-10	10-50	50-120
±0.15	±0.2	±0.5	±1°	±0.5°	±0.3°
120-250	250-400	400-700	120-250	250-360	360 above
±0.8	±1.5	±2	±0.2°	±0.166°	±0.083°



Technical requirements:

1. Material:  $t=1.0\text{mm}$  1070AL.
2. Surface treatment: Outer surface with painting, interior standard light.
3. Product untolerance reference untolerance table.

					Engineering drawings		<b>Nata<sup>®</sup></b> <b>NATA Lighting Co.,Ltd</b>	
Mark	Amended Times	Amended Content		Signature	Amended Date	Customer Item		
Control Version	AO	Design Version	KO	Client Version		Customer Code	NT	
Designer	Drawing by		Proportion	1:1		Product Number	91.15.0020.000	
Technology	Auditor		View			Product Name	15-0020-K	
Approval	Date	2019.07.04	Page	Total Page				